

Dwg No:

APFL-H-BOM

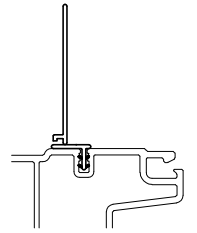

OPTIONAL
NAILING FIN

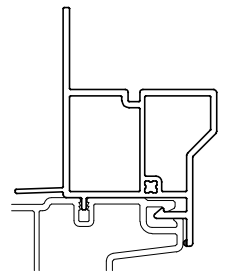

OPTIONAL
BRICKMOULD

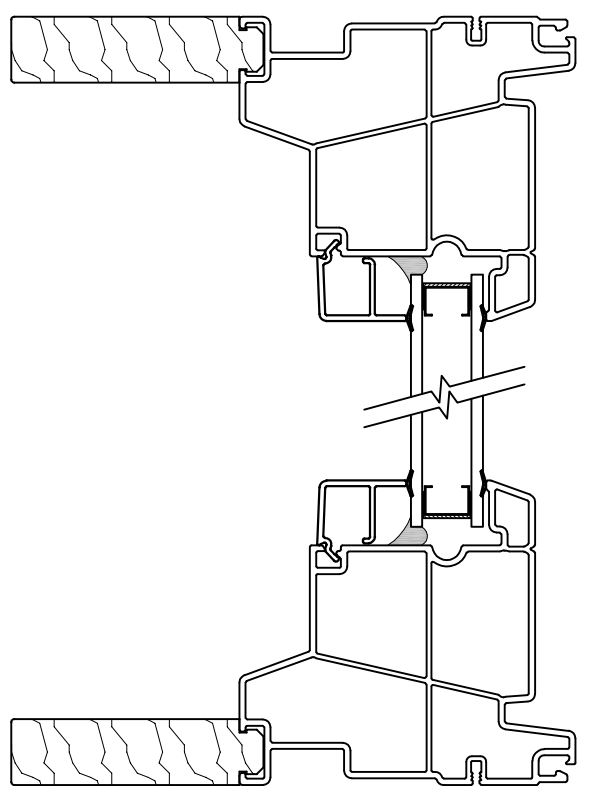

ADVANTAGE PLUS FIXED IN SASH

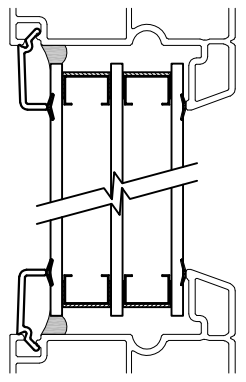

OPTIONAL - TRIPLE PANE

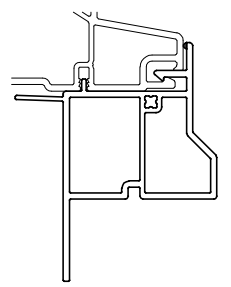

OPTIONAL
BRICKMOULD

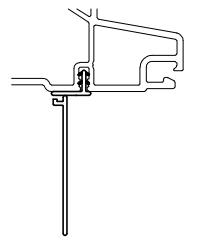

OPTIONAL
NAILING FIN

REV	DATE	DESCRIPTION	DATE: 03/07/17
			SCALE: 1:2
			DRAWN BY: A.V.
			DRAWING NAME: APFL - HORIZONTAL SECTION



POLLARD WINDOWS INC.
1217 KING ROAD
BURLINGTON, ON
L7R 3Y3

THIS DOCUMENT IS THE INTELLECTUAL PROPERTY OF POLLARD WINDOWS INC.
IT MAY NOT BE COPIED, MODIFIED OR PASSED ON TO THIRD PARTIES WITHOUT WRITTEN PERMISSION.

Dwg No:

APFL-V-BOM

OPTIONAL
NAILING FIN

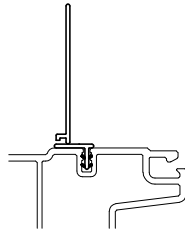

OPTIONAL
BRICKMOULD

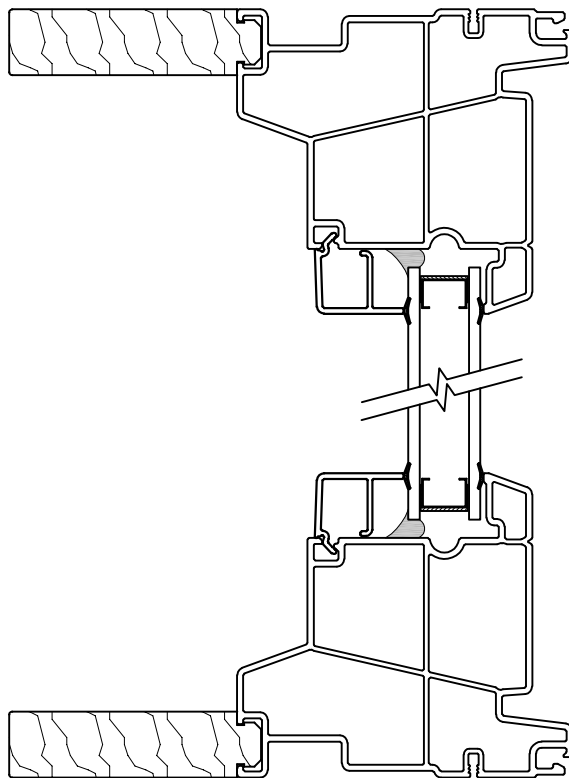
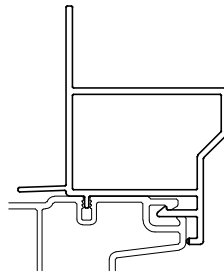

ADVANTAGE PLUS FIXED IN SASH

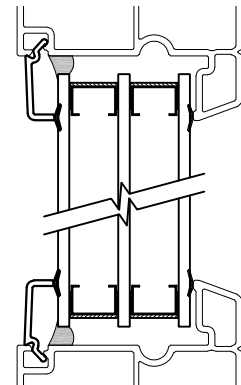

OPTIONAL - TRIPLE PANE

OPTIONAL
BRICKMOULD

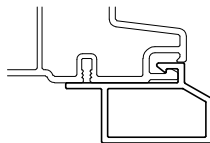

OPTIONAL
NAILING FIN

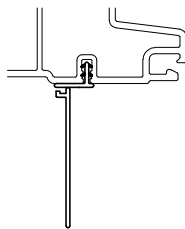

			DATE:	02/21/17
			SCALE:	1:2
			DRAWN BY:	A.V.
REV	DATE	DESCRIPTION	DRAWING NAME:	APFF - VERTICAL SECTION



POLLARD WINDOWS INC.
1217 KING ROAD
BURLINGTON, ON
L7R 3Y3

THIS DOCUMENT IS THE INTELLECTUAL PROPERTY OF POLLARD WINDOWS INC.
IT MAY NOT BE COPIED, MODIFIED OR PASSED ON TO THIRD PARTIES WITHOUT WRITTEN PERMISSION.

Dwg No:

APFF-H-BOM

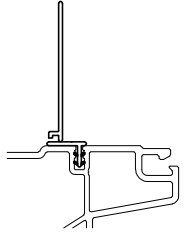

OPTIONAL
NAILING FIN

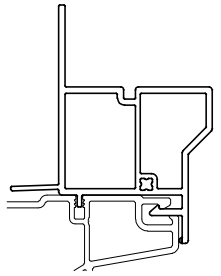

OPTIONAL
BRICKMOULD

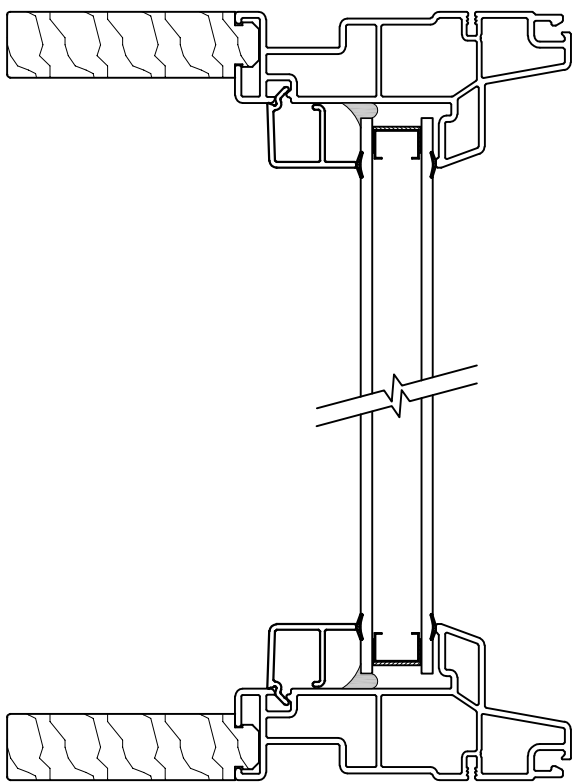

ADVANTAGE PLUS FIXED IN FRAME

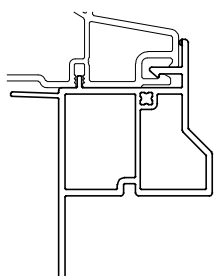

OPTIONAL
BRICKMOULD

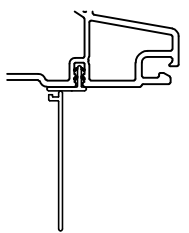

OPTIONAL
NAILING FIN

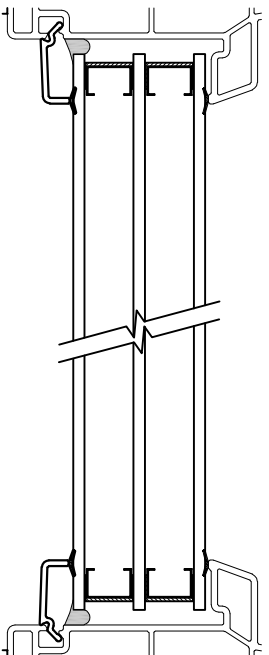

OPTIONAL - TRIPLE PANE

REV	DATE	DESCRIPTION	DATE: 03/07/17
			SCALE: 1:2
			DRAWN BY: A.V.
			DRAWING NAME: APFF - HORIZONTAL SECTION



POLLARD WINDOWS INC.
1217 KING ROAD
BURLINGTON, ON
L7R 3Y3

THIS DOCUMENT IS THE INTELLECTUAL PROPERTY OF POLLARD WINDOWS INC.
IT MAY NOT BE COPIED, MODIFIED OR PASSED ON TO THIRD PARTIES WITHOUT WRITTEN PERMISSION.

Dwg No:

APFF-V-BOM

OPTIONAL
NAILING FIN

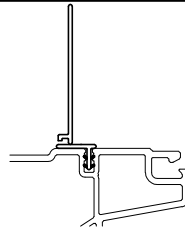

OPTIONAL
BRICKMOULD

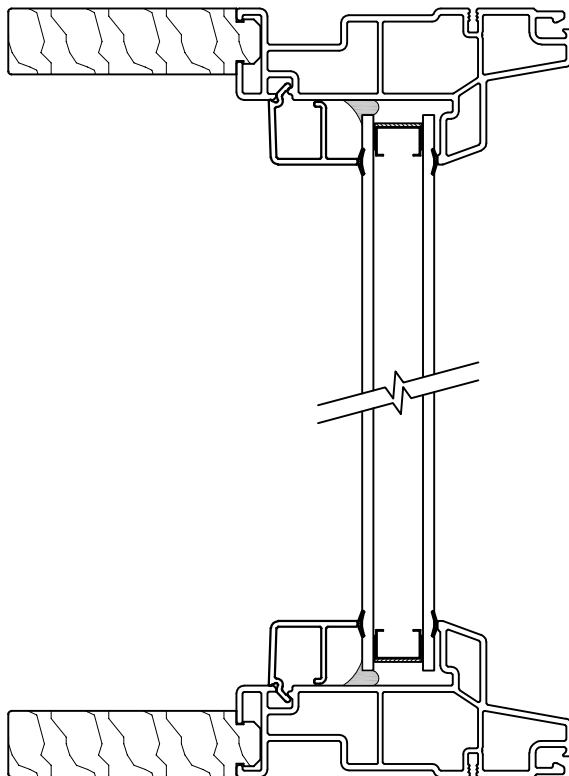
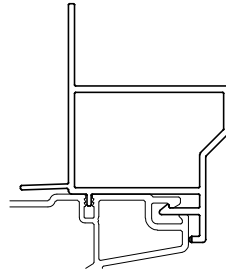

ADVANTAGE PLUS FIXED IN FRAME

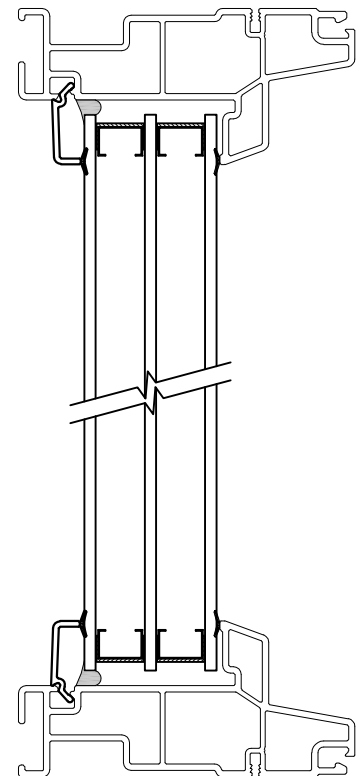

OPTIONAL - TRIPLE PANE

OPTIONAL
BRICKMOULD

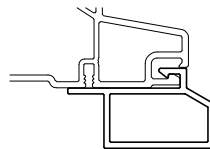

OPTIONAL
NAILING FIN

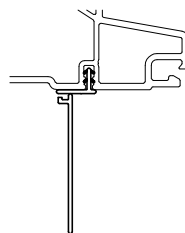

DATE: 02/21/17

SCALE: 1:2

DRAWN BY: A.V.

DRAWING NAME: APFF - VERTICAL SECTION



POLLARD WINDOWS INC.
1217 KING ROAD
BURLINGTON, ON
L7R 3Y3

REV DATE DESCRIPTION

THIS DOCUMENT IS THE INTELLECTUAL PROPERTY OF POLLARD WINDOWS INC.
IT MAY NOT BE COPIED, MODIFIED OR PASSED ON TO THIRD PARTIES WITHOUT WRITTEN PERMISSION.

Dwg No:

APTU-H-BOM

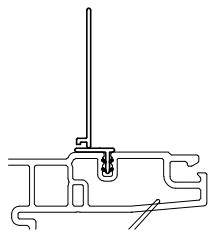

OPTIONAL
NAILING FIN

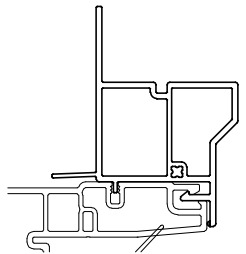

OPTIONAL
BRICKMOULD

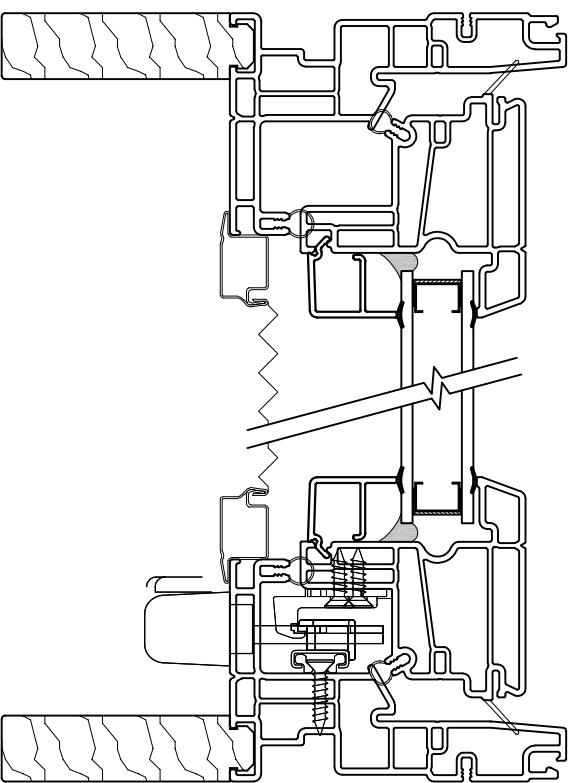

ADVANTAGE PLUS TUDOR (CASEMENT)

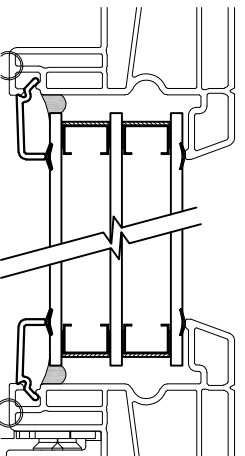

OPTIONAL - TRIPLE PANE

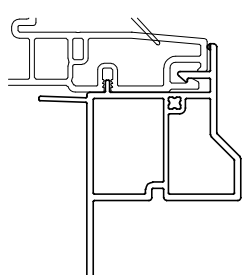

OPTIONAL
BRICKMOULD

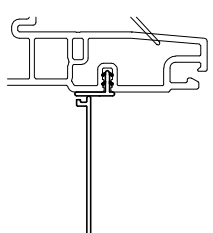

OPTIONAL
NAILING FIN

REV	DATE	DESCRIPTION	DATE: 03/07/17
			SCALE: 1:2
			DRAWN BY: A.V.
			DRAWING NAME: APTU - HORIZONTAL SECTION



POLLARD WINDOWS INC.
1217 KING ROAD
BURLINGTON, ON
L7R 3Y3

THIS DOCUMENT IS THE INTELLECTUAL PROPERTY OF POLLARD WINDOWS INC.
IT MAY NOT BE COPIED, MODIFIED OR PASSED ON TO THIRD PARTIES WITHOUT WRITTEN PERMISSION.

Dwg No:

APTU-V-BOM

OPTIONAL
NAILING FIN

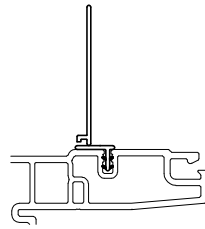

OPTIONAL
BRICKMOULD

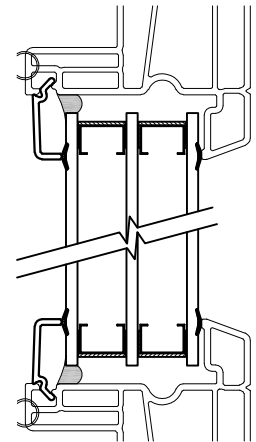
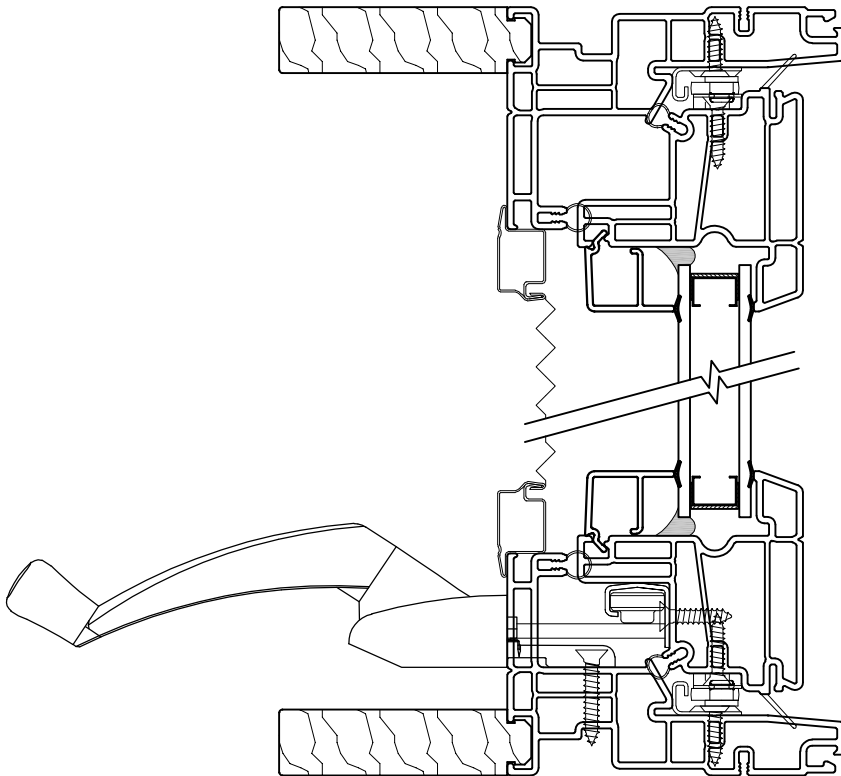
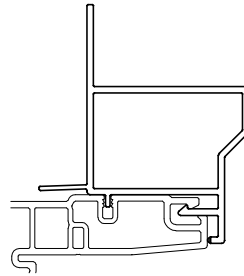

OPTIONAL - TRIPLE PANE

ADVANTAGE PLUS TUDOR (CASEMENT)

OPTIONAL
BRICKMOULD

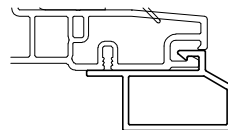

OPTIONAL
NAILING FIN

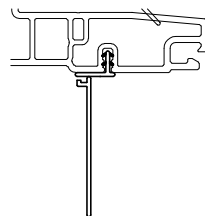

			DATE:	02/21/17
			SCALE:	1:2
			DRAWN BY:	A.V.
REV	DATE	DESCRIPTION	DRAWING NAME:	APTU - VERTICAL SECTION

POLLARD WINDOWS INC.
1217 KING ROAD
BURLINGTON, ON
L7R 3Y3

THIS DOCUMENT IS THE INTELLECTUAL PROPERTY OF POLLARD WINDOWS INC.
IT MAY NOT BE COPIED, MODIFIED OR PASSED ON TO THIRD PARTIES WITHOUT WRITTEN PERMISSION.

Dwg No:

APCA-H-BOM

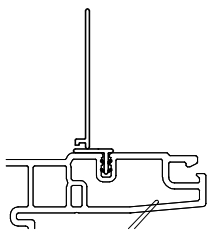

OPTIONAL
NAILING FIN

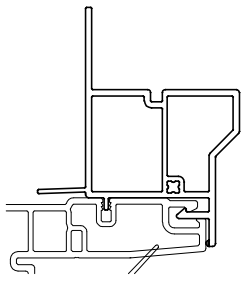

OPTIONAL
BRICKMOULD

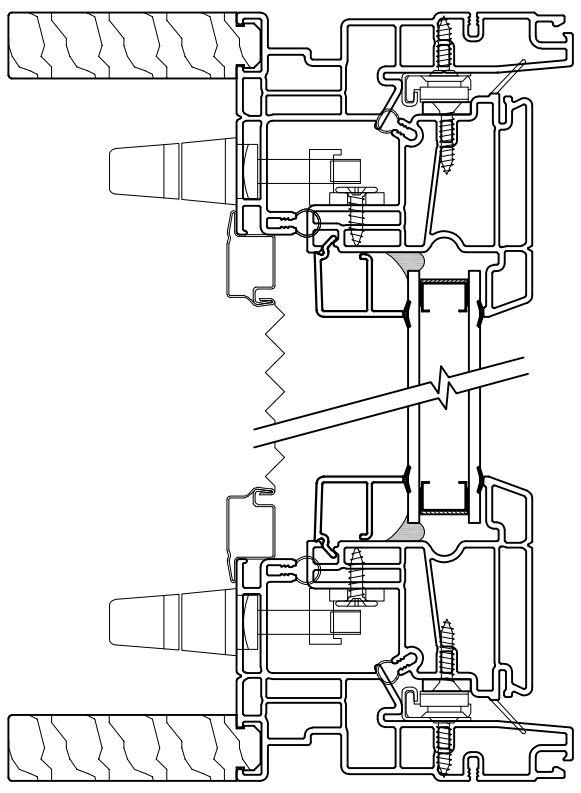

ADVANTAGE PLUS AWNING (CASEMENT)

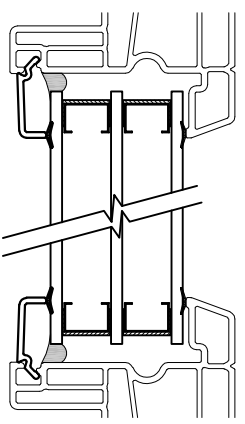

OPTIONAL - TRIPLE PANE

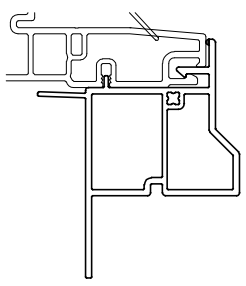

OPTIONAL
BRICKMOULD

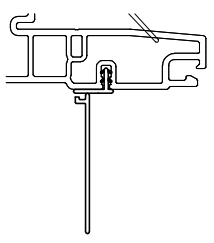

OPTIONAL
NAILING FIN

REV	DATE	DESCRIPTION	DATE: 03/07/17
			SCALE: 1:2
			DRAWN BY: A.V.
			DRAWING NAME: APCA - HORIZONTAL SECTION



POLLARD WINDOWS INC.
1217 KING ROAD
BURLINGTON, ON
L7R 3Y3

THIS DOCUMENT IS THE INTELLECTUAL PROPERTY OF POLLARD WINDOWS INC.
IT MAY NOT BE COPIED, MODIFIED OR PASSED ON TO THIRD PARTIES WITHOUT WRITTEN PERMISSION.

Dwg No:

APCA-V-BOM

OPTIONAL
NAILING FIN

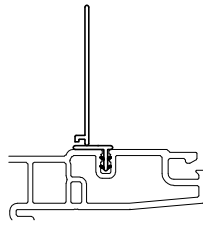

OPTIONAL
BRICKMOULD

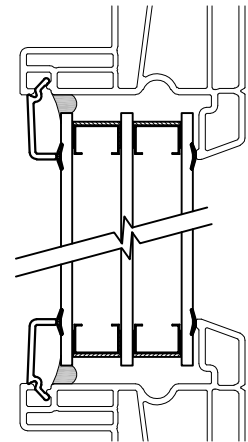
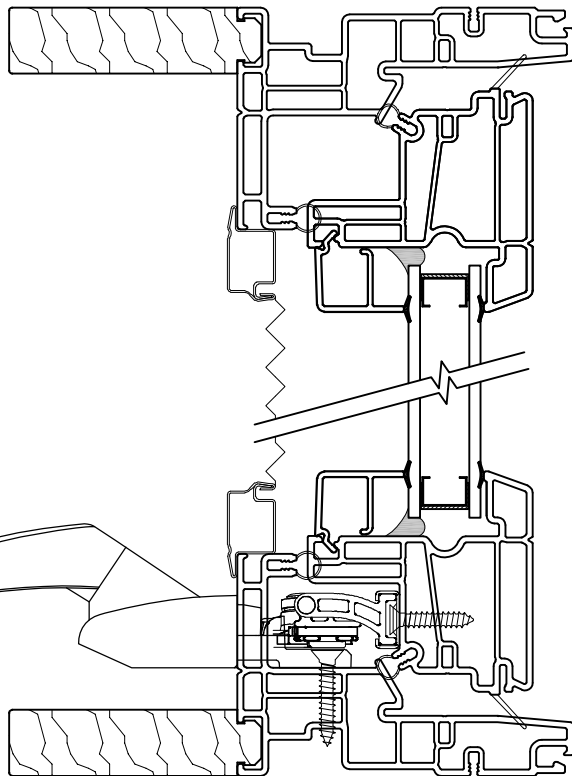
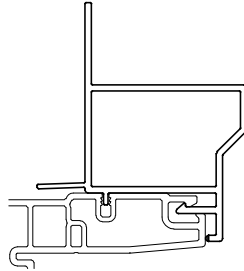

OPTIONAL - TRIPLE PANE

ADVANTAGE PLUS TUDOR (CASEMENT)

OPTIONAL
BRICKMOULD

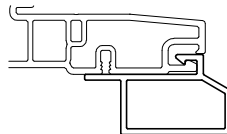

OPTIONAL
NAILING FIN

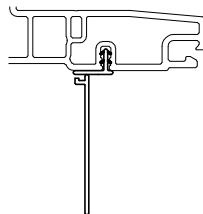

			DATE:	02/21/17
			SCALE:	1:2
			DRAWN BY:	A.V.
REV	DATE	DESCRIPTION	DRAWING NAME:	APTU - VERTICAL SECTION



POLLARD WINDOWS INC.
1217 KING ROAD
BURLINGTON, ON
L7R 3Y3

THIS DOCUMENT IS THE INTELLECTUAL PROPERTY OF POLLARD WINDOWS INC.
IT MAY NOT BE COPIED, MODIFIED OR PASSED ON TO THIRD PARTIES WITHOUT WRITTEN PERMISSION.