

Dwg No:

ATW-H-BOM

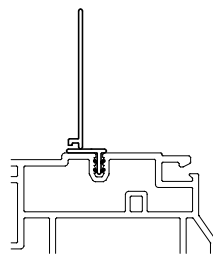

OPTIONAL
NAILING FIN

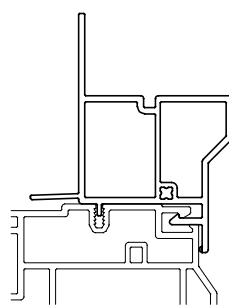

OPTIONAL
BRICKMOULD

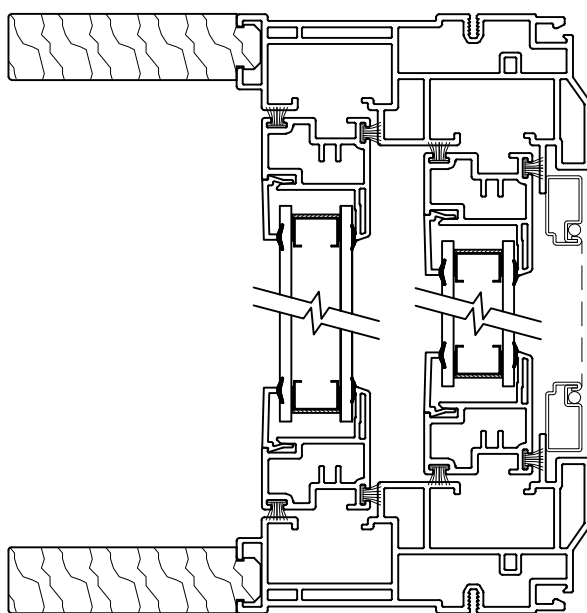

ADVANTAGE DOUBLE HUNG

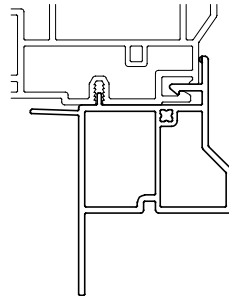

OPTIONAL
BRICKMOULD

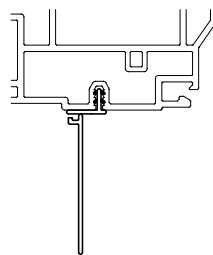

OPTIONAL
NAILING FIN

REV	DATE	DESCRIPTION	DATE: 02/21/17
			SCALE: 1:2
			DRAWN BY: A.V.
			DRAWING NAME: ATW - HORIZONTAL SECTION



POLLARD WINDOWS INC.
1217 KING ROAD
BURLINGTON, ON
L7R 3Y3

THIS DOCUMENT IS THE INTELLECTUAL PROPERTY OF POLLARD WINDOWS INC.
IT MAY NOT BE COPIED, MODIFIED OR PASSED ON TO THIRD PARTIES WITHOUT WRITTEN PERMISSION.

Dwg No:

ATW-V-BOM

OPTIONAL
NAILING FIN

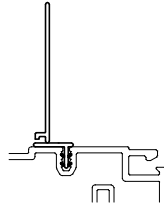

OPTIONAL
BRICKMOULD

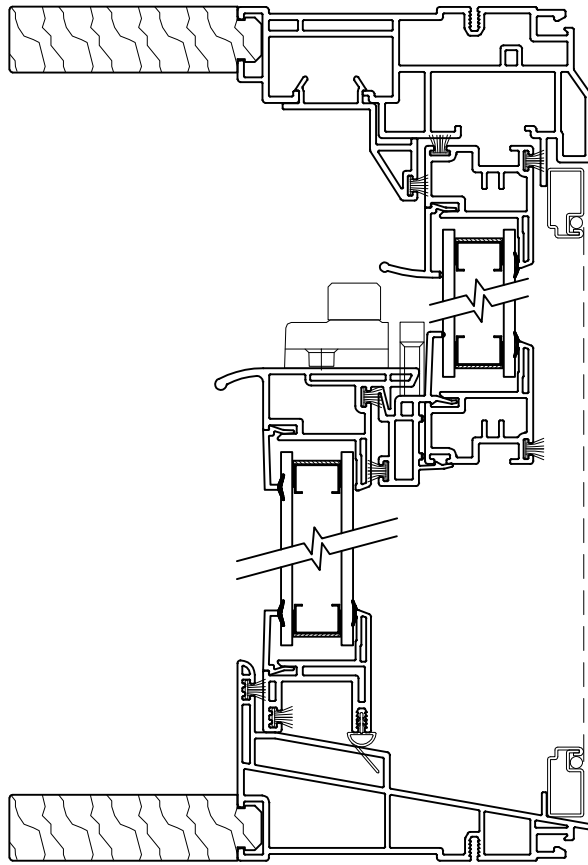
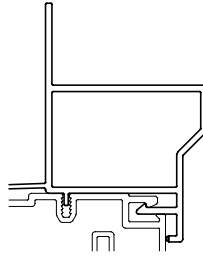

ADVANTAGE DOUBLE HUNG

OPTIONAL
BRICKMOULD

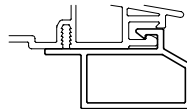

OPTIONAL
NAILING FIN

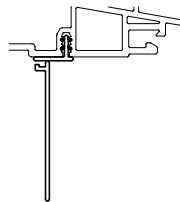

DATE: 02/21/17

SCALE: 1:2

DRAWN BY: A.V.

DRAWING NAME: ATW - VERTICAL SECTION



POLLARD WINDOWS INC.
1217 KING ROAD
BURLINGTON, ON
L7R 3Y3

REV DATE DESCRIPTION

THIS DOCUMENT IS THE INTELLECTUAL PROPERTY OF POLLARD WINDOWS INC.
IT MAY NOT BE COPIED, MODIFIED OR PASSED ON TO THIRD PARTIES WITHOUT WRITTEN PERMISSION.

Dwg No:

ASH-H-BOM

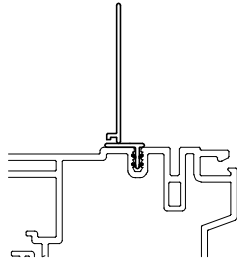

OPTIONAL
NAILING FIN

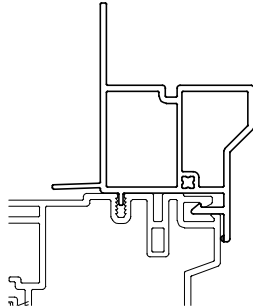

OPTIONAL
BRICKMOULD

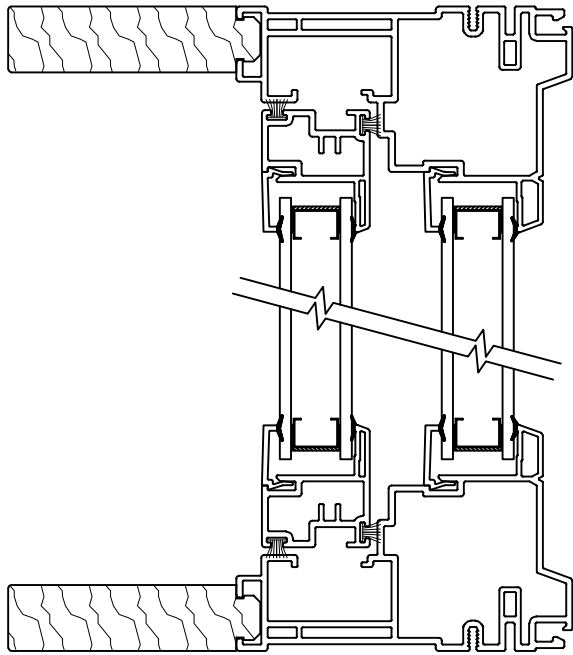

ADVANTAGE SINGLE HUNG

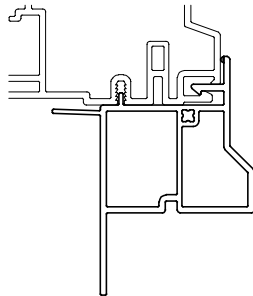

OPTIONAL
BRICKMOULD

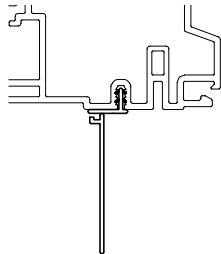

OPTIONAL
NAILING FIN

REV	DATE	DESCRIPTION	DATE: 02/21/17
			SCALE: 1:2
			DRAWN BY: A.V.
			DRAWING NAME: ASH - HORIZONTAL SECTION



POLLARD WINDOWS INC.
1217 KING ROAD
BURLINGTON, ON
L7R 3Y3

THIS DOCUMENT IS THE INTELLECTUAL PROPERTY OF POLLARD WINDOWS INC.
IT MAY NOT BE COPIED, MODIFIED OR PASSED ON TO THIRD PARTIES WITHOUT WRITTEN PERMISSION.

Dwg No:

ASH-V-BOM

OPTIONAL
NAILING FIN

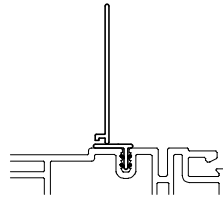

OPTIONAL
BRICKMOULD

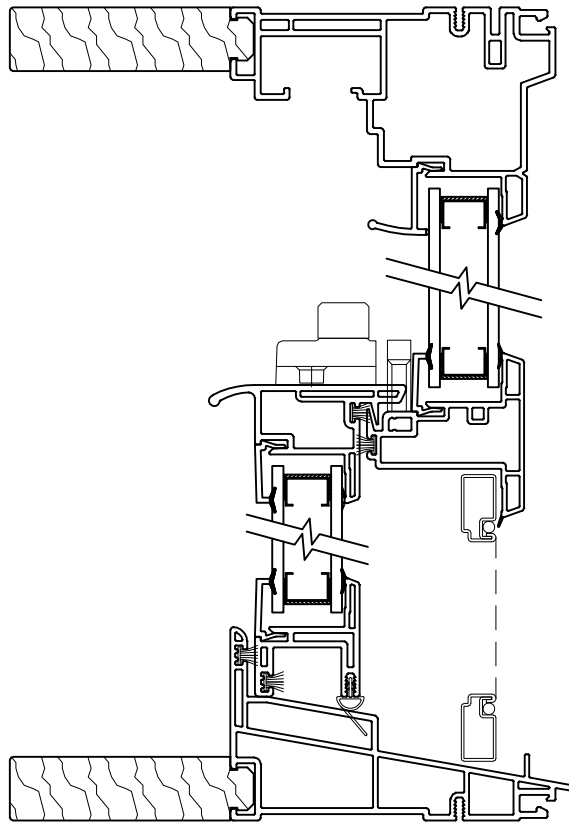
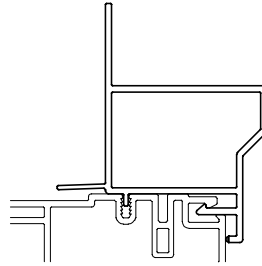

ADVANTAGE SINGLE HUNG

OPTIONAL
BRICKMOULD

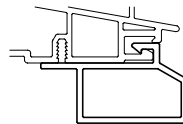

OPTIONAL
NAILING FIN

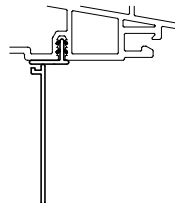

DATE: 02/21/17

SCALE: 1:2

DRAWN BY: A.V.

DRAWING NAME: ASH - VERTICAL SECTION



POLLARD WINDOWS INC.
1217 KING ROAD
BURLINGTON, ON
L7R 3Y3

REV DATE DESCRIPTION

THIS DOCUMENT IS THE INTELLECTUAL PROPERTY OF POLLARD WINDOWS INC.
IT MAY NOT BE COPIED, MODIFIED OR PASSED ON TO THIRD PARTIES WITHOUT WRITTEN PERMISSION.

Dwg No:

AGL-H-BOM

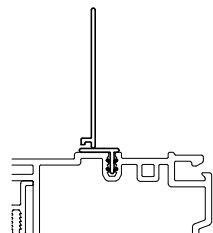

OPTIONAL
NAILING FIN

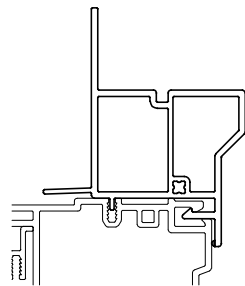

OPTIONAL
BRICKMOULD

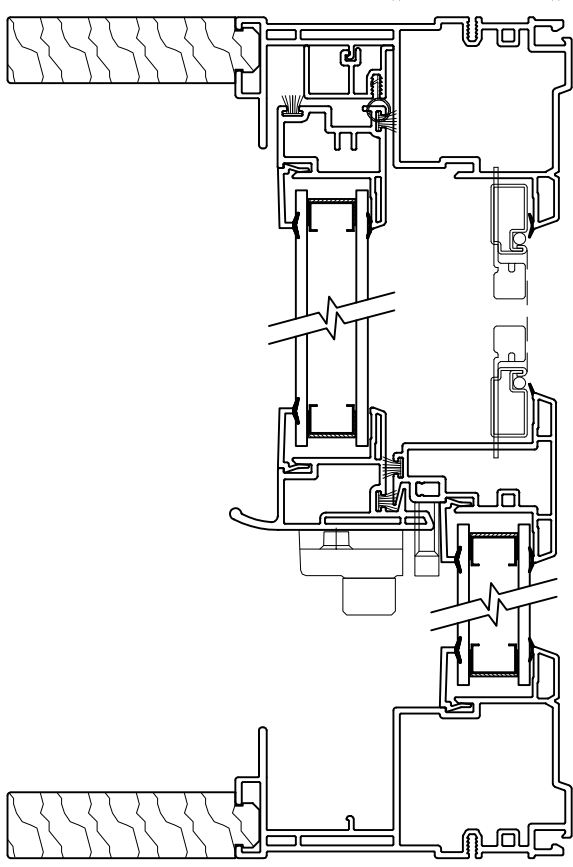

ADVANTAGE SLIDER

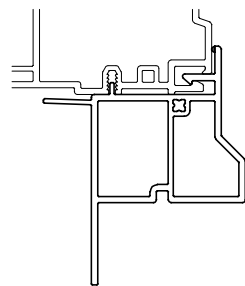

OPTIONAL
BRICKMOULD

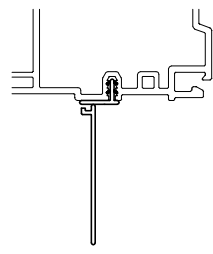

OPTIONAL
NAILING FIN

REV	DATE	DESCRIPTION	DATE: 02/21/17
			SCALE: 1:2
			DRAWN BY: A.V.
			DRAWING NAME: AGL - HORIZONTAL SECTION



POLLARD WINDOWS INC.
1217 KING ROAD
BURLINGTON, ON
L7R 3Y3

THIS DOCUMENT IS THE INTELLECTUAL PROPERTY OF POLLARD WINDOWS INC. IT MAY NOT BE COPIED, MODIFIED OR PASSED ON TO THIRD PARTIES WITHOUT WRITTEN PERMISSION.

Dwg No:

AGL-V-BOM

OPTIONAL
NAILING FIN

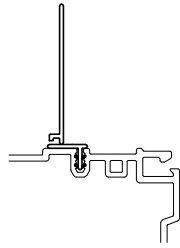

OPTIONAL
BRICKMOULD

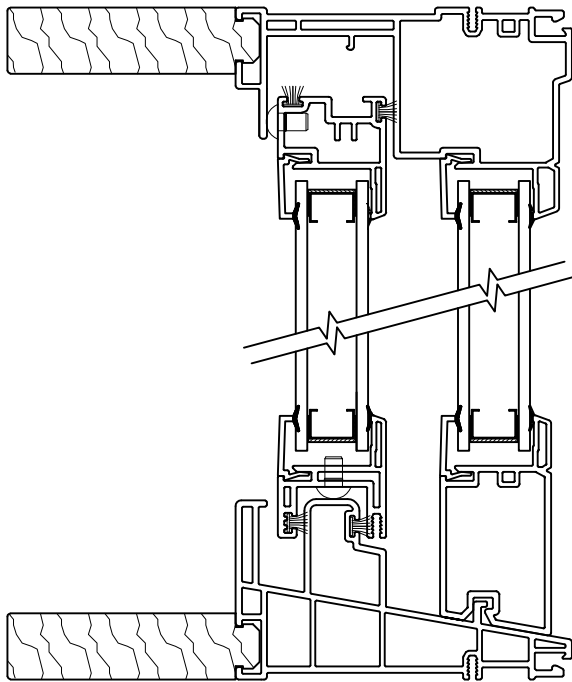
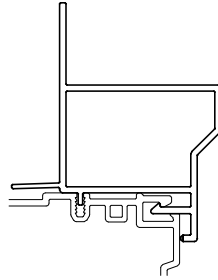

ADVANTAGE GLIDER

OPTIONAL
BRICKMOULD

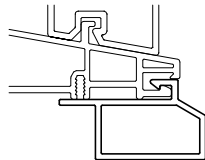

OPTIONAL
NAILING FIN

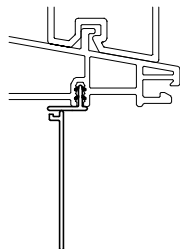

DATE: 02/21/17

SCALE: 1:2

DRAWN BY: A.V.

DRAWING NAME: AGL - VERTICAL SECTION



POLLARD WINDOWS INC.
1217 KING ROAD
BURLINGTON, ON
L7R 3Y3

REV	DATE	DESCRIPTION
-----	------	-------------

THIS DOCUMENT IS THE INTELLECTUAL PROPERTY OF POLLARD WINDOWS INC.
IT MAY NOT BE COPIED, MODIFIED OR PASSED ON TO THIRD PARTIES WITHOUT WRITTEN PERMISSION.